

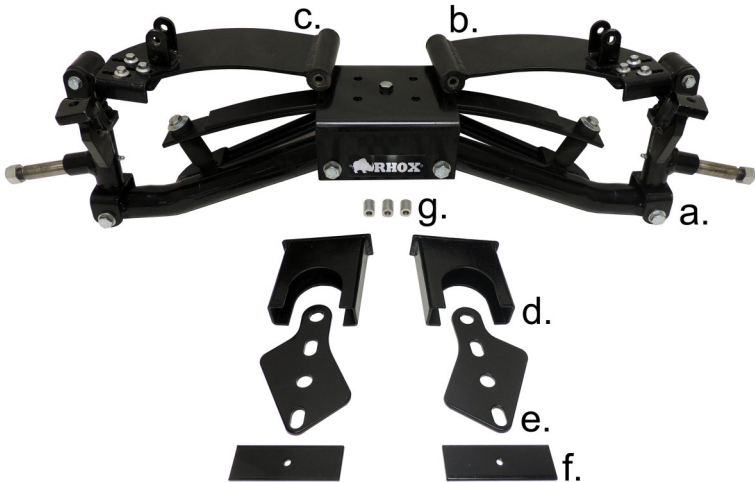

LIFT-503 BMF Lift Kit Club Car Precedent Installation Instructions



Contents of LIFT-503 Club Car Precedent BMF Lift Kit:

- a (1 ea.) BMF Front Suspension
- b (1 ea.) Driver Side Upper A-Arm (Shipped Loose)
- c (1 ea.) Passenger Side Upper A-Arm (Shipped Loose)
- d (2 ea.) Riser Blocks
- e (2 ea.) Shock Mounting Plates
- f (2 ea.) Centering Plates
- g (3 ea.) 8mm x 20mm Steering Rack Spacers
- h (1 ea.) Box of Hardware (Contents on Next Page)
- i (1 ea.) Instructions

Caution: Please read through the instructions carefully. Installer is responsible for damage if instructions are not followed properly. Extra installers will be helpful in some parts of the installation. Please refer to all torquing specifications on page 2 for installation.

Note: You must install larger tires and wheels once the cart is lifted. Stock wheels will not work. We recommend a 22" tire with a minimum of a 10" offset wheel for use on the RHOOX BMF Lift Kit.

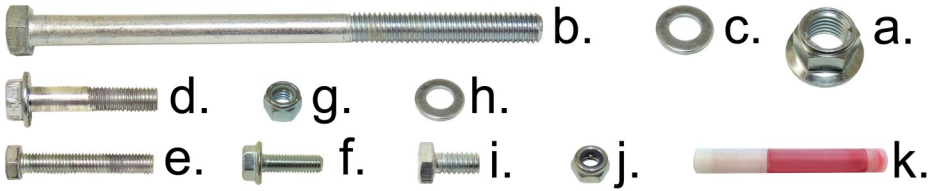

Contents of LIFT-503 Hardware Kit:

<u>ITEM</u>	<u>QTY.</u>	<u>DESCRIPTION</u>	<u>TORQUE REQUIREMENTS</u>
a.	2 ea.	16mm Nylock Nuts	-
b.	4 ea.	7/16" x 7" Hex Head Bolts	54 ft. lbs.
c.	8 ea.	7/16" Flat Washers	-
d.	4 ea.	10mm x 50 Flange Head Bolts	45 ft. lbs.
e.	5 ea.	8mm x 50 Hex Head Bolts	22 ft. lbs.
f.	6 ea.	8mm x 25 Flange Head Bolts	22 ft. lbs.
g.	8 ea.	8mm Nylock Nuts	-
h.	10 ea.	8mm Flat Washers	-
i.	2 ea.	6mm x 10 Hex Head Bolts	6 ft. lbs.
j.	2 ea.	6mm Nylock Nuts	-
k.	1 ea.	Thread Locking Compound	-

Installation Preparation (Front of the Cart)

1. Engage the parking brake and place the key in the Off position.
2. If your cart has a Tow/Run Switch, place switch in the Tow position.
3. Chock the back of the rear wheels to prevent the cart from moving.
4. Remove the hub caps (if any). Loosen the lug nuts on both of the front wheels. Do not remove the lug nuts.
5. Using a jack, safely lift the front end of the cart enough to accommodate the additional height of the larger tires and wheels.



6. Place jack stands securely under the chassis and remove jack.
7. Remove the front bumper by removing the two bolts holding it in place. Retain the bumper and the hardware.



8. Fully remove the (8) front lug nuts, tires and wheels. Discard the tires and wheels as they will not be reused.
9. Remove the front hubs by removing the flange nut in the center of the hub. Retain hubs and discard hardware.

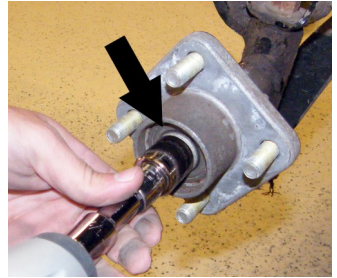

10. Disconnect the tie rod ends from the spindles by removing the safety pin from the tie rod end. Then remove the nut on the tie rod end. Use a wrench to keep the tie rod end in place as the nut is removed. Retain hardware.

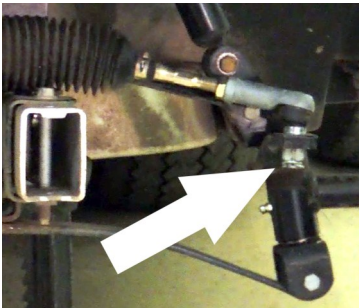

11. Disconnect the shocks from the top clevis by removing the bolt on the bottom of the shocks as shown to the right. Discard hardware.

12. Remove the (3) bolts in the steering rack. Discard hardware.

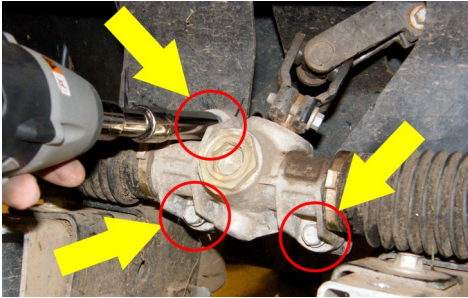

13. With the steering rack out of the way, remove the bolts that attach the upper A-Arms to the chassis. Retain hardware.

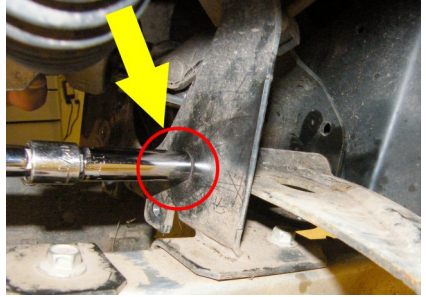

14. Remove the original front suspension from the chassis by removing the (4) bolts from under the leaf spring clamp. Discard Hardware.

NOTE: Additional help is recommended during this step to help support the front suspension during removal.

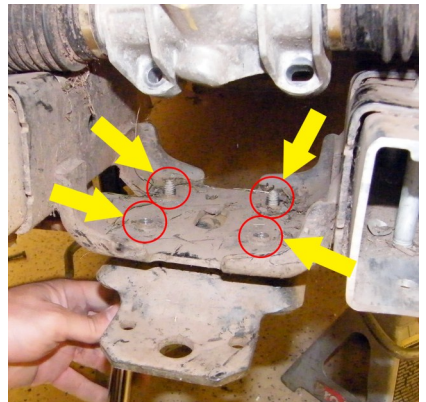

BMF Front Suspension Installation

NOTE: Please refer to page 2 for torquing specifications for included hardware. Please refer to vehicle's maintenance manual for torquing specifications on reused hardware.

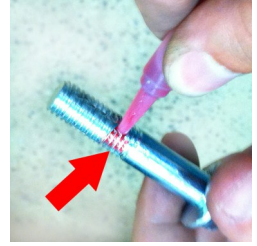

1. Position the new BMF front suspension in front of the cart with the *RHOX* plate facing forward.
2. Cut the tip on the Thread Locking Compound to allow a small opening. Put a drop of Thread Locking Compound on the threads of the (4) 10mm x 50 Flange Head Bolts.
3. Using the (4) 10mm x 50 Flange Head Bolts with Thread Locking Compound, bolt the new BMF front suspension to the chassis where the original suspension was removed.

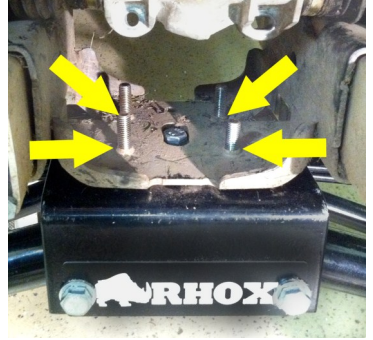

NOTE: Additional help is recommended during this step to help support the front suspension during installation.

4. Identify the BMF A-Arms. Using the Original Hardware, attach the upper portion of the A-Arms to the chassis.

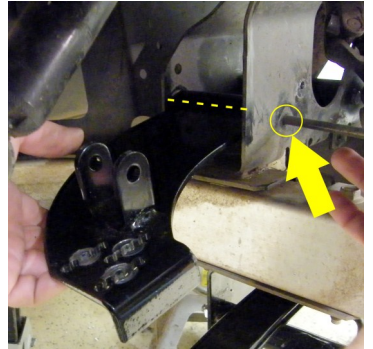

NOTE: Pushing the steering rack out of the way will make this step easier.

5. Next, the A-Arms will be attached to the BMF spindle assemblies. Place a jack under the arm connected to the spindle to relieve the tension in the spring and to raise the spindle to the A-Arm.



6. Attach the A-Arms to the spindle assemblies using (6) 8mm x 25 Flange Head Bolts, (6) 8mm Flat Washers and (6) 8mm Nylock Nuts. There are (5) adjustable camber positions. To start, it is recommended to use the second position from the outside of the cart. Final adjustments can be made once all tires are installed.



7. Attach the shocks to the A-arm shock mounts using the (2) 8mm x 50 Hex Head Bolts, (4) 8mm Flat Washers and (2) 8mm Nylock Nuts.

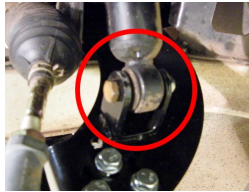

8. Locate the steering joint attached to the steering rack. It will be behind the chassis and above the A-Arms. Loosen the bolt at the top of the joint. Do not remove completely.

9. Locate the (3) 8mm x 20mm Steering Rack Spacers, (3) 8mm x 50 Hex Head Bolts and the Thread Locking Compound. Put a drop of Thread Locking Compound on the threads of the (3) 8mm x 50 Hex Head Bolts.

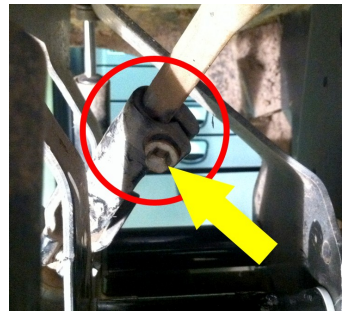
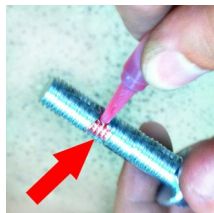

10. Reinstall the steering rack with the (3) 8mm x 20mm Steering Rack Spacers between the steering rack and the chassis using the (3) 8mm x 50 Hex Head Bolts with Thread Locking Compound.

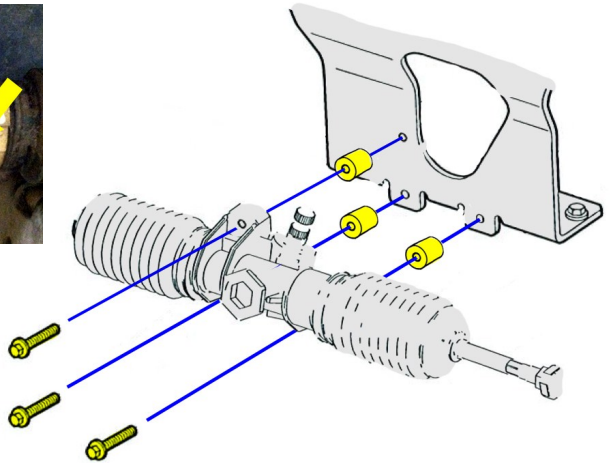
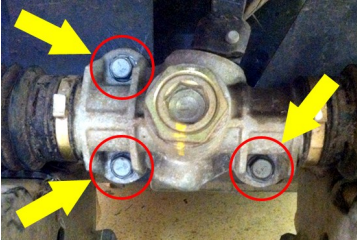

11. After the steering rack is secure, tighten the bolt on the steering joint that was loosened in Step 8.
12. Reinstall the tie rod ends onto the spindles using the Original Hardware and Safety Pins.



13. Reinstall the front hubs removed on page 3 using the (2) 16mm Nylock Nuts provided in the hardware kit.

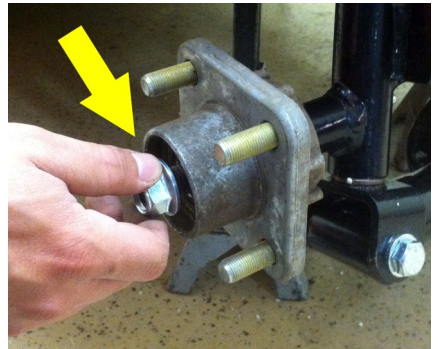

14. Install the (2) front tires. The stock tires and wheels will not work on the newly lifted cart. Fully tighten the lug nuts on both wheels.

NOTE: It is recommended to use at least 22" tires on a 10" wheel with an offset. The wheel shown is a *RHOX Vegas TIR-RX160* with a *RHOX Mojave* tire, TIR-265.

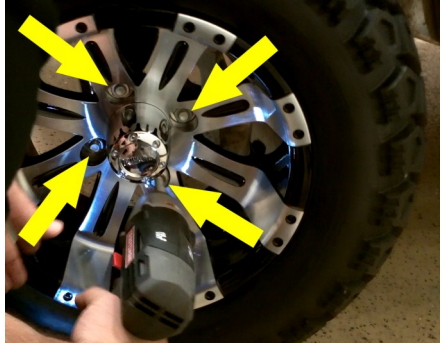

15. Once the tire and wheels are fully secure, place the jack under the cart. Remove any jack stands and lower the cart safely to the ground. Remove the chocks behind the rear wheels.

NOTE: The front bumper will remain off until the camber and toe adjustments are made at the end of the installation.

Installation Preparation (Rear of the Cart)

1. Engage the parking brake and place the key in the Off position.
2. If the cart has a Tow/Run switch, place it in the Tow position.
3. Chock the front of the front wheels to prevent the cart from moving.
4. Remove the hub caps (if any) on the rear wheels. Loosen the lug nuts on both rear wheels. Do not remove the lug nuts.
5. Place a jack securely under the rear axle. Safely lift the rear end of the cart enough to accommodate the additional height of the larger tires and wheels.
6. Place jack stands under the chassis on both sides of the cart to stabilize it. DO NOT remove the jack.
7. Fully remove the (8) rear lug nuts, tires and wheels. Discard the tires and wheels as they will not be reused.



BMF Rear Suspension Installation

Safety Note:

Proper eye and mouth protection should be worn during this section to protect the installer from falling debris when working under the cart.

The rear axle is only held up by the (2) leaf springs and the jack. For safety reasons, complete one side of the suspension at a time. The photos below show the Driver side.

1. Unbolt the bottom portion of the driver side shock from the shock mounting plate. Push the shock upward and out of the way.

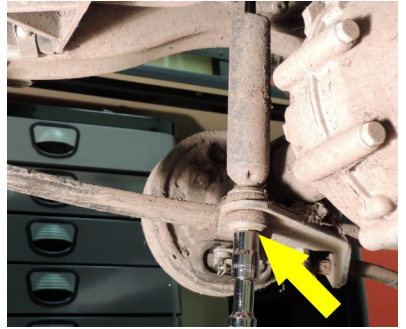

2. With the axle supported by the jack, remove the (2) nuts holding the driver side U-bolt around the rear axle, leaf spring and shock mounting plate. Remove and discard the U-bolt but retain the (2) nuts.

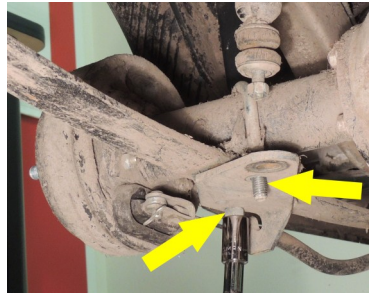

3. Remove the driver's side leaf spring from the rear shackle by removing the shackle bolt on the rear portion of the leaf spring. Retain hardware.



4. Remove the front portion of the leaf spring by removing front pivot bolt. This bolt is also secures the clamp that holds the brake cable. Retain hardware.
5. Remove the leaf spring.
6. Carefully lower the rear axle away from the chassis with the jack. The jack stands will remain in place to support the chassis.

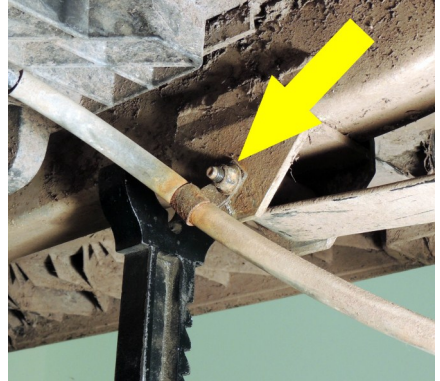

7. Place the leaf spring on top of the axle.

8. Reattach the front portion of the leaf spring and the brake cable removed in step 4 using the original pivot bolt. If the brake cable is too short, leave the brake cable loose and support it with a heavy duty wire tie versus the factory brake cable clamp.

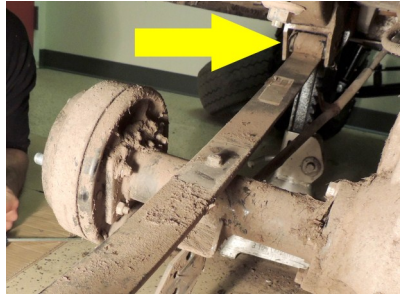

9. Place a riser block on top of the axle and under the leaf spring. When oriented correctly, it will lean to the front of the cart. The captured nut on the bottom of the leaf spring will seat in the hole on the riser block.

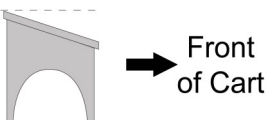
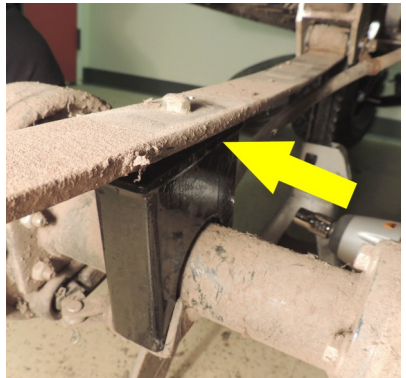

10. Once the spring is seated, identify the shock mounting plate included in the BMF kit. Place it on top of the leaf spring. The captured nut will seat in the small hole. The larger, shock mounting hole will face towards the center rear of the cart as shown.

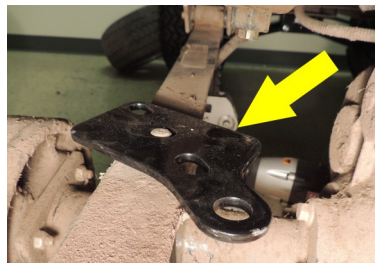

11. Install (1) 6mm x 10 Hex Head Bolt and (1) 6mm Nylock Nut onto the centering plate. Place the centering plate between the original shock mounting plate and the leaf spring mounting perch on the bottom of the axle. The 6mm bolt head and nut will fit into the center hole of the spring perch and original shock mounting plate to aid in alignment.

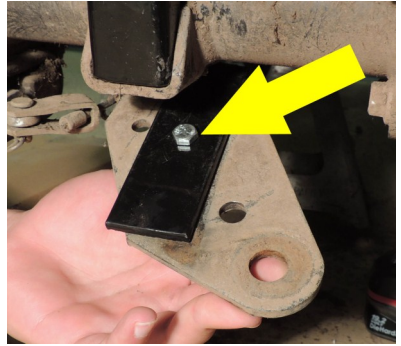

12. Install the centering plate assembly to the rear axle, riser block, leaf spring and new shock mounting bracket using (2) 7/16" x 7" Hex Head Bolts, (4) 7/16" Flat Washers and the (2) 7/16" Nuts retained from the U-bolt in Step 2. Hand tighten.

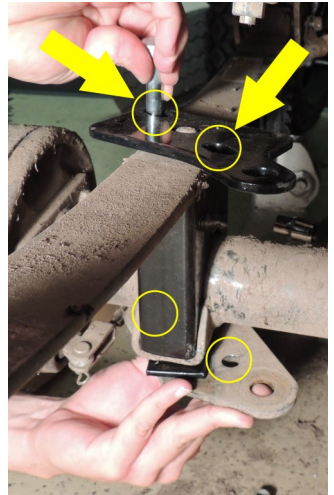

13. Fully tighten both bolts. Adjustments may be needed to keep all plates and brackets aligned.

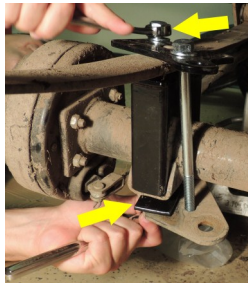

14. Repeat steps 1-13 for the passenger side rear leaf spring.

15. Using the jack, safely lift the rear axle and guide the rear portion of the leaf springs to their original positions.

16. Reinstall the rear portion of the leaf springs to the shackles using the Original Hardware removed in step 3.

17. Pull down the shock and bolt it onto the new shock mounting plate using the Original Hardware.

18. If the cart is not high enough to accommodate the larger tires and wheels, raise the cart to the right height with the jack.

19. Install the (2) rear tires/wheels on the rear hubs.

20. Remove the jack stands and lower the cart.

21. Remove the jack.



Adjust the Toe and Camber

1. Drive forward and back 20-40 feet to check the toe and camber before making adjustments. Only make adjustments if needed.

NOTE: For stability, an $1/8$ " toe-in with a positive camber is recommended. This will level out when the cart is loaded.

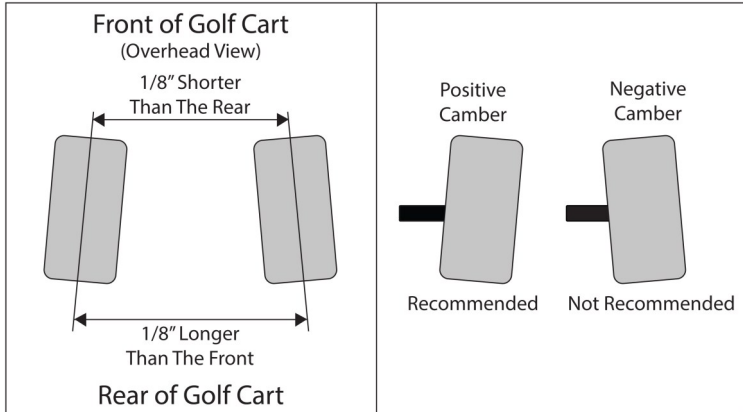

Toe-In Adjustment

Camber Adjustment

2. Adjust the toe by loosening the jam nut. Lengthen or shorten the tie rod by turning the hex shaped rod adjustment. Shortening the tie rods increases the toe, lengthening decreases it.
3. Adjust the camber by lengthening or shortening the A-arm adjustments.
4. Once camber and toe adjustments are finalized and set, tighten all hardware and jam nuts.
5. Reinstall the front bumper with the original hardware.



This completes the installation of your Precedent BMF Lift Kit.
Please enjoy safely!

Watch this installation and others on YouTube:
www.youtube.com/user/GolfCartInstructions